

IP66 UFO LED Highbay Fixture

Product appearance:

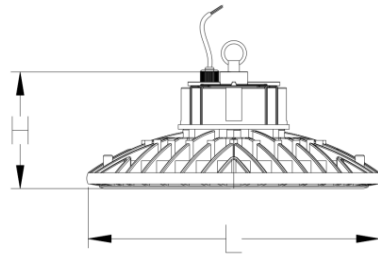

Product specification:

Part Number	Dimension(L*H)(mm)	Carton Dimension	Pieces/Carton	Carton G/W(KGS)
060W	320*137	420*408*410	2	8.2
100W	320*137	420*408*410	2	8.8
150W	320*139	420*408*410	2	9.85
200W	430*142	465*465*200	1	8
240W	430*150	465*465*200	1	8.5
150W	320*106	420*408*410	2	9.6
200W	430*110	465*465*200	1	7.8
240W	430*110	465*465*200	1	7.8

D1-1 Surface Mount (Mount kit as option)

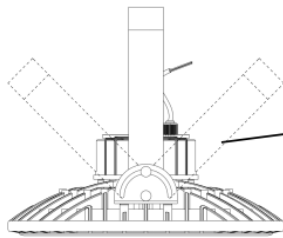

You can adjust the Angle, the range is plus or minus 90 degrees

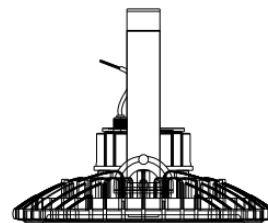
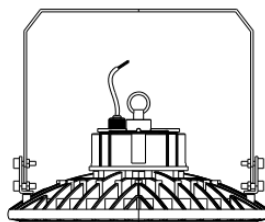
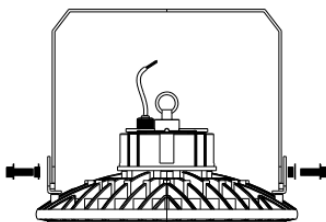
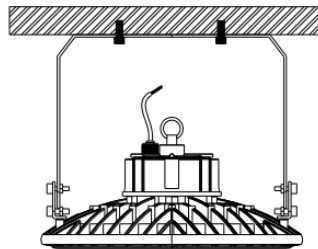
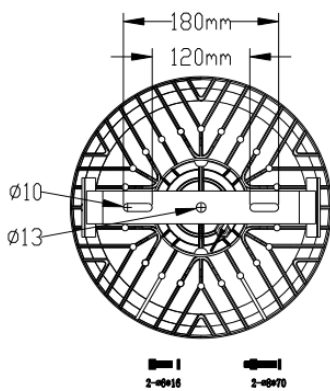

D1-2 Pole Mount:

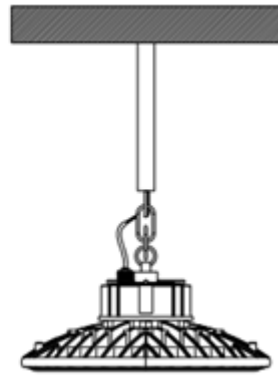
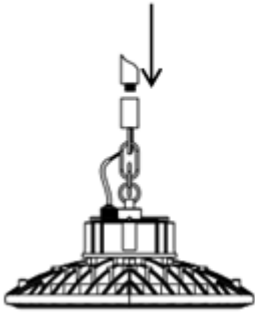

D1-3 Chain Mount: (Standard)

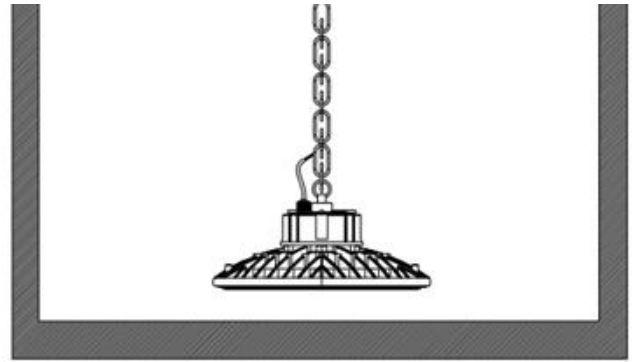
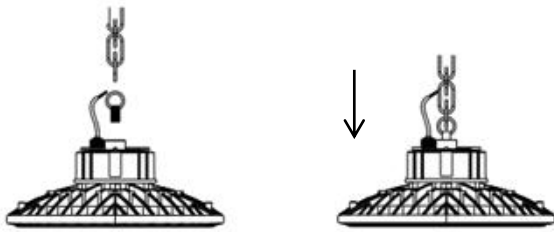

D1-1 Surface Mount:

1. Install the setscrews into ceiling.
2. Fix the bracket on the lamp to the setscrews and fasten them tightly. Connect wire (EU: Brown Blue Yellow& Green, US: Black White Yellow& Green)wire L N E.
3. Adjust bracket to the suitable angle for the application

D1-2 Pole Mount :

1. Install a prepared Pole (not included) into the ceiling, and please ensure the installation and the pole can carry at least 3 times the weight of the lamp before installing.
2. Screw the pole hook(not included) into the pole make sure it firmly, Screw the hanging ring (included) clockwise into the hole on top of the lamp.
3. Hang the lamp on the hook and connect (EU: Brown Blue Yellow& Green, US: Black White Yellow& Green) wire L N E.

D1-3 Chain Mount:

1. Install a prepared hook (not included) into the ceiling, and please ensure the installation and the hook can carry at least 3 times the weight of the lamp before installing.
2. Screw the hanging ring (included) clockwise into the hole on top of the lamp.
3. Hang the lamp on the hook and connect (EU: Brown Blue Yellow& Green, US: Black White Yellow& Green) wire L N E.